

COMPONENTS REQUIRED

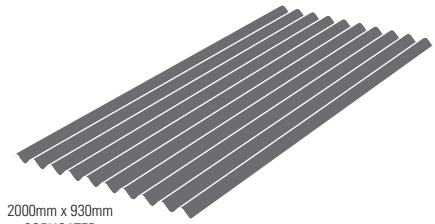

2000mm x 930mm
CORUGATED
BITUMEN SHEETS

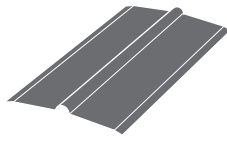

1000mm x 450mm
ROOF RIDGES



COLOUR-MATCHED
ROOF NAILS

TOOLS REQUIRED



PROTECTIVE
GLOVES



PROTECTIVE
GLASSES



SPRAY
LUBRICATING
OIL

see
TOP TIPS
page 3



COARSE TOOTH
HAND SAW



OR
POWER
SAW



HAMMER



TAPE
MEASURE



STRAIGHT
EDGE

INSTALLATION

1

MEASURE
ROOF

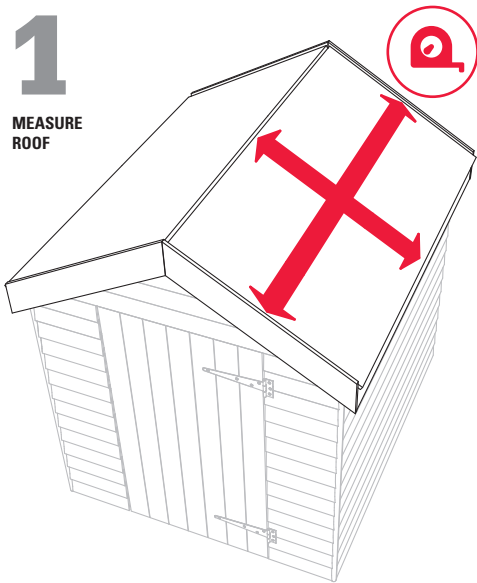

2

INSTALL FIRST
CORUGATED
BITUMEN SHEET

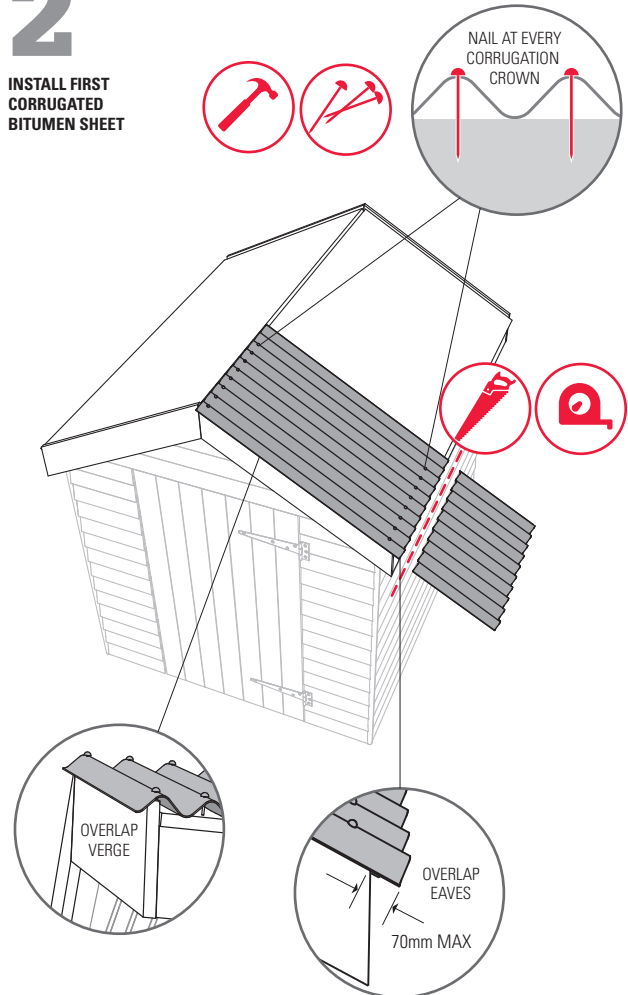

3

INSTALL SECOND
CORUGATED
BITUMEN SHEET

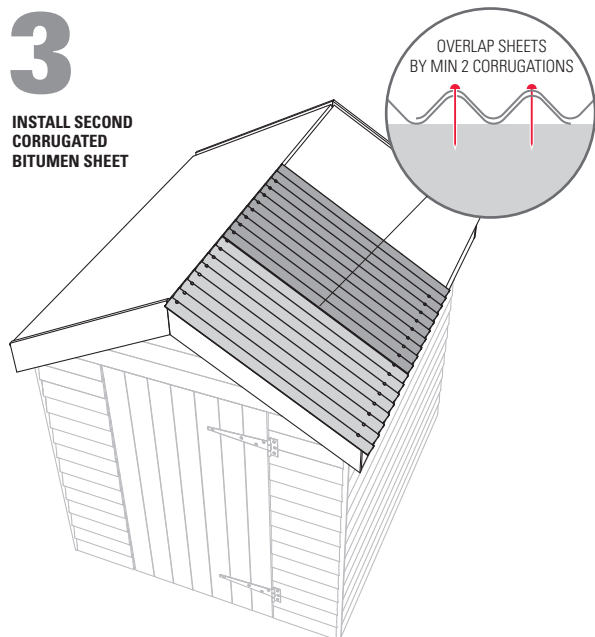

INSTALLATION

4

INSTALL FINAL CORRUGATED BITUMEN SHEET

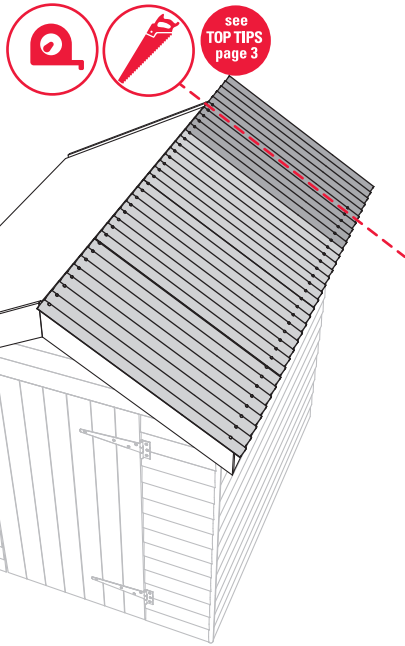

5

FOLD AND NAIL ROOF VERGES

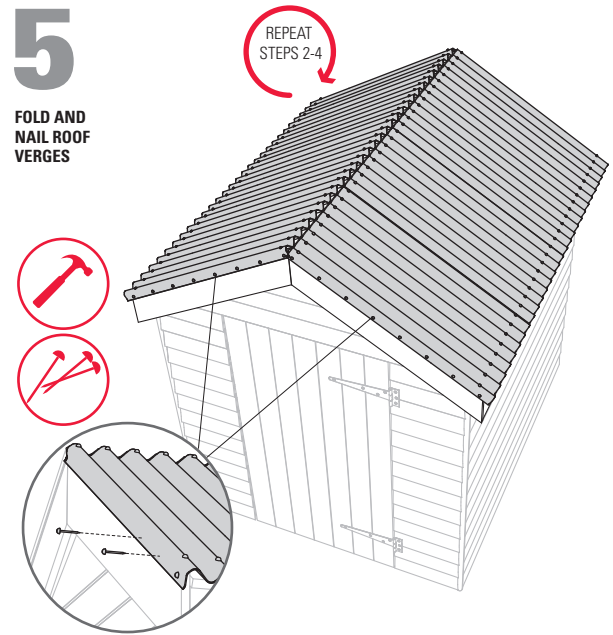

6

INSTALL ROOF RIDGES

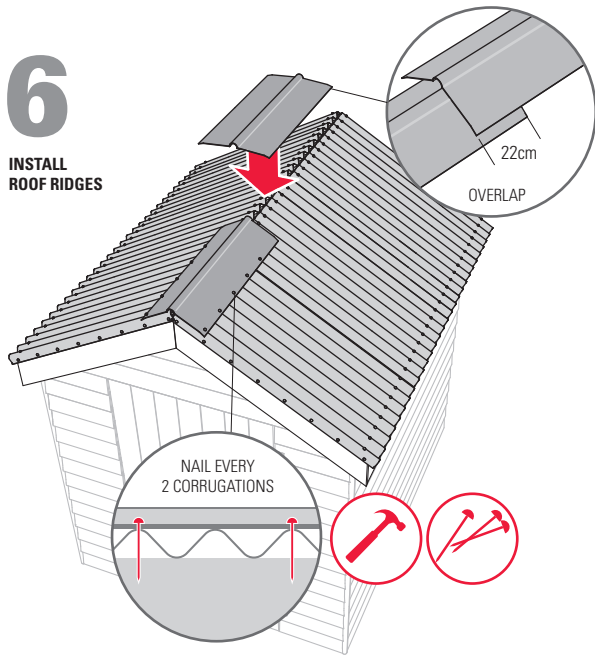

7

COMPLETE THE INSTALLATION

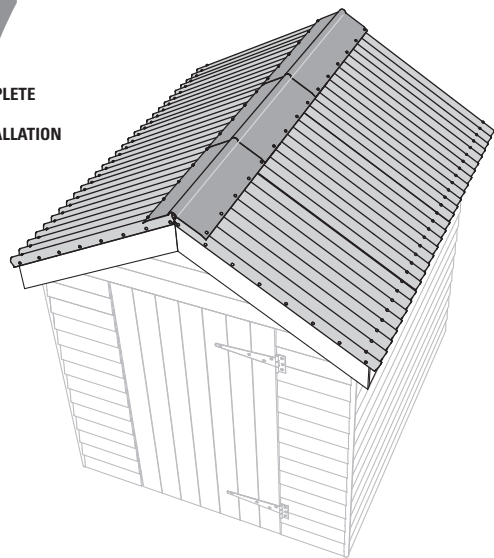

INSTALLATION ON LARGER ROOFS

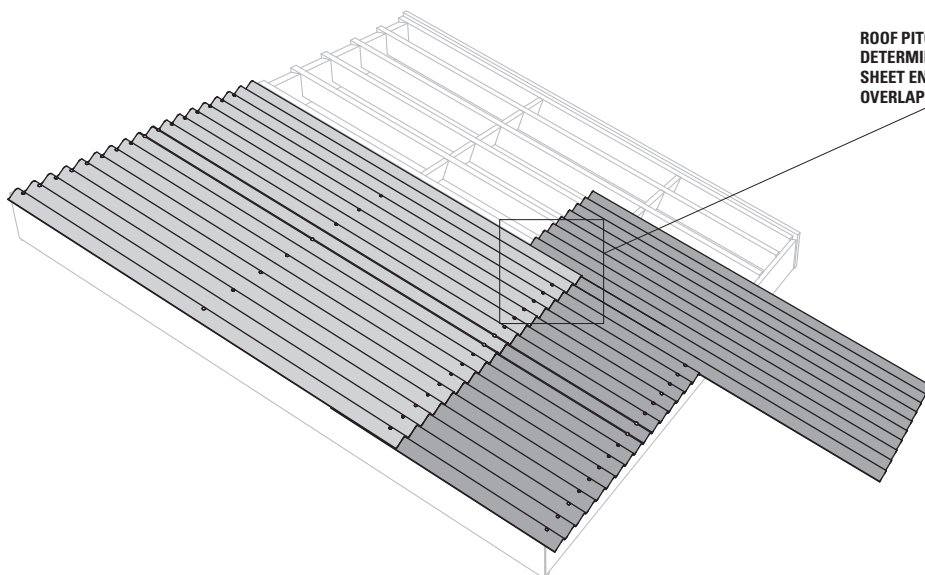

ROOF PITCH DETERMINES SHEET END OVERLAP

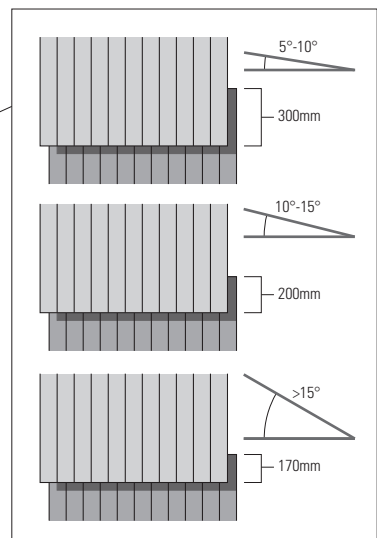

1 AVOID THE NECESSITY FOR VERTICAL CUTS BY OVERLAPPING ROOF SHEETS BY MORE THAN 2 CORRUGATIONS TO EXACTLY MATCH THE ROOF DIMENSION

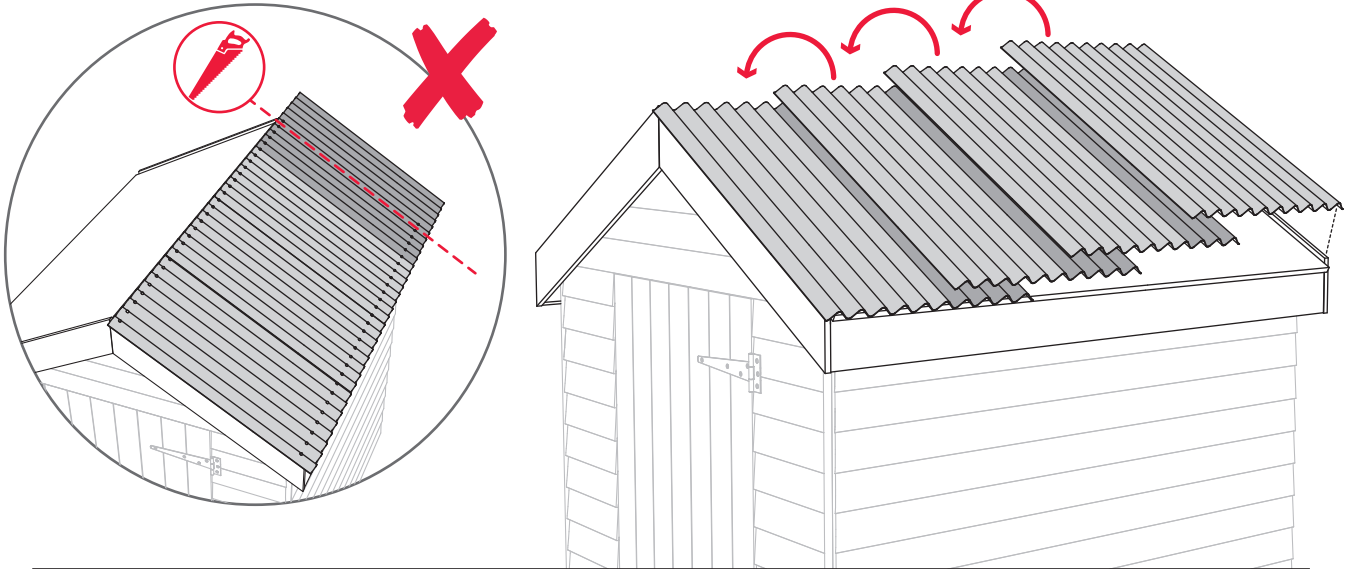

2 PRIOR TO MAKING HORIZONTAL CUTS GIVE YOUR SAW BLADE A FEW SQUIRTS OF LUBRICATING OIL - IT'LL MAKE THE JOB A LOT EASIER.

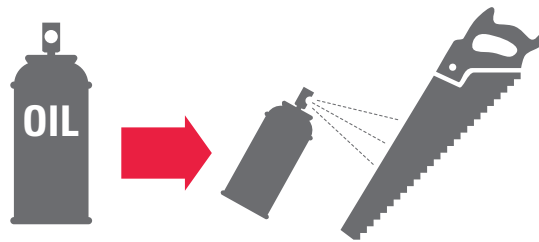

3 **IMPORTANT** - TO KEEP YOUR NEW ROOF WATERTIGHT AND WEATHERPROOF, ENSURE THAT YOU ALWAYS NAIL THE ROOF SHEETS THROUGH THE CROWN OF THE CORRUGATION, NEVER THROUGH THE GULLEY.

